

Datasheet Flow Meter Connector 290312000

Compatible with
Sensirion

- *SFM3200-AW*
- *SFM3300-AW*
- *SFM3300-D*
- *SFM3400-AW*
- *SFM3400-D*

*SENSIRION
Flow Meter Series*



*NICOLAY
Flow Meter
Connector*



1. Introduction

The Nicolay flow meter connector is the perfect connection to the Sensirion flow meter. The mechanical interface has been designed to provide an easy and user-friendly connection and separation between the flow meter connector and the flow meter, yet is so robust and stable that it is suitable for respiratory applications in ventilation or anesthesia. An integrated gasket on the flow meter connector ensures an IP54 classification when plugged in and additionally the possibility of wipe disinfection when not plugged in.

2. Functionality

The Sensirion mass flow meter uses a thermal measurement method with a heating element and two temperature sensors. The heating element generates a thermal cloud above the temperature sensors in the flow channel. With the gas flow, the thermal cloud shifts and the flow is determined by the height of the resulting temperature difference between the two sensors. This technology offers advantages over other measuring principles in terms of speed and high accuracy. An additional heating element, which prevents the formation of condensate in the sensor, ensures a moisture-independent measurement.

3. Applications

- Proximal flow measurement
- Expiratory flow measurement
- For ventilation & anesthesia
- Respiratory measurements
- Metabolic measurements

4. Dimensional Specification

| Position | Description | Material | Color |
|----------|-------------------------------|----------|------------------------|
| 6 | Strain bend relief | M-PUR | Black similar RAL 9005 |
| 5 | 6-pin pogo pin connector | CuZn | Surface AU |
| 4 | Sealing | Silicone | Black similar RAL 9005 |
| 3 | Cover | PUR | Black similar RAL 9005 |
| 2 | Housing | PUR | Black similar RAL 9005 |
| 1 | 6-lead shielded cable Ø 4,5mm | M-PUR | Black similar RAL 9005 |

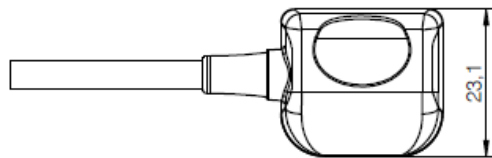
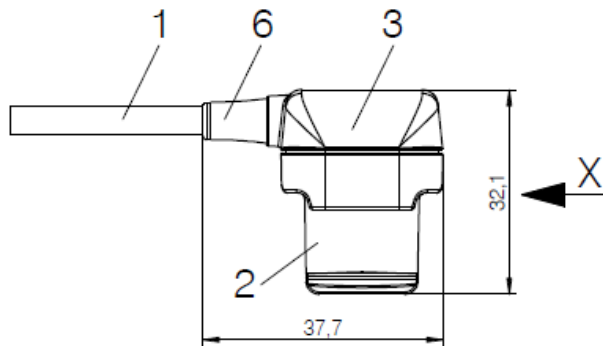
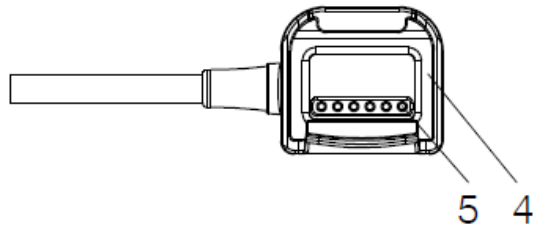

X

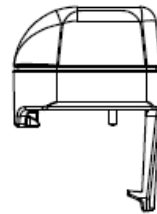

1:2

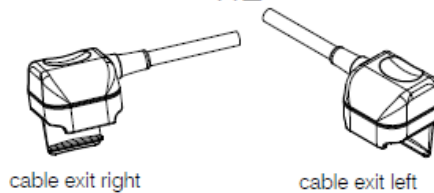

5. Connector Configurations

The Nicolay flow meter connector is available in three different configurations. For short cable length until maximum 30 cm, a direct connection from the pogo pins to the cable is sufficient to enable a proper signal transmission. For a cable length larger than 30 cm the Nicolay flow meter connector could be assembled with a circuit board for communication with the Sensirion I²C bus. The signal is evaluated and transmitted via an RS485 or RS232 interface (detailed information in the communication protocol). The communication protocol is available upon request. A customized PCB-layout can be offered alternatively. To support the application, cable outlets on both sides of the connector are possible.

Variants

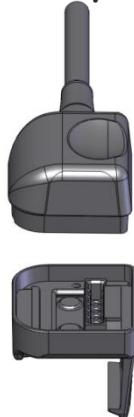

*With I²C interface,
for cable length less
than 30 cm*

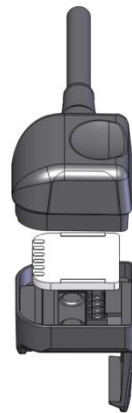

With RS485 interface

PCB

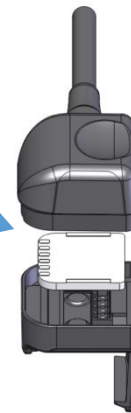

With RS232 interface

6. Connection Options

For a good connection to the device Nicolay offers the *mini7/mini12* connector system. The connector system provides excellent support for this application. It is also available with an IP classification of IP 64 when plugged in. Further information on the Nicolay connector system can be found on our website:

<http://www.nicolay.com/en/produktgruppen/steckverbinder>

An **USB-connection** for a direct connection to the computer is also available.

A connector assembly from third party suppliers is possible on request. Please contact us for further technical clarification.

Flow Meter Connector

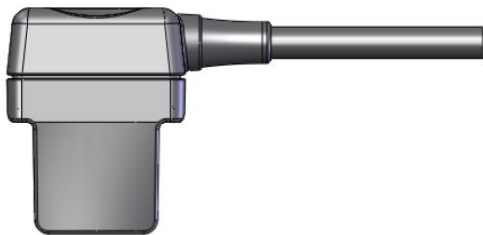

NICOLAY mini7/mini12 Plug



NICOLAY mini7/mini12 Device Connector

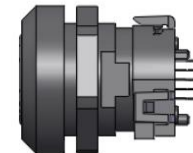



*USB-connection
(only with RS485)*

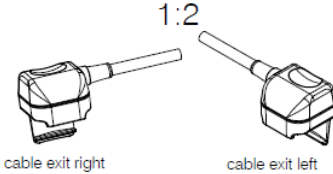

7. Inquiry Form

Please use this form to specify your requirements and send the filled out form to info@nicolay.de

| Configuration Options | Nicolay standard | Customer specific cable |
|--|---|--|
| Cable length | 200cm | 25cm – 400cm |
| Select cable exit  | <input type="radio"/> left <input type="radio"/> right | <input type="radio"/> left <input type="radio"/> right |
| Select PCB communication protocol | <input type="radio"/> RS485 <input type="radio"/> RS232 <input type="radio"/> I ² C | <input type="radio"/> RS485 <input type="radio"/> RS232 <input type="radio"/> I ² C |
| Select device connector interface  | <input type="radio"/> NICOLAY mini7 plug <input type="radio"/> USB connection <input type="radio"/> Without connector | <input type="radio"/> NICOLAY mini7 plug <input type="radio"/> NICOLAY mini12 plug <input type="radio"/> USB connection <input type="radio"/> Without connector <input type="radio"/> Other connectors |
| quantity | Minimum order quantity: 10pcs | Serial product: Minimum 2500pcs/year |

NICOLAY

GREAT PERFORMANCE ENGINEERING

For further information please contact:



Phone: +49 7452 823 138

E-mail: joel.bischoff@nicolay.de

Website: www.nicolay.de

Nicolay GmbH
Graf-Zeppelin-Str. 21
72202 Nagold
Germany